

lead screw stepper motors



- 2-phase hybrid motor (bipolar)
- with stranded wires
- exact lead screw assembly by H7 fit
- lead screw assembly possible on both sides
- optional with encoder

part number									
MOT	ST								
28	L								
A	A								
<table border="1"> <thead> <tr> <th colspan="2">specifcs</th> </tr> </thead> <tbody> <tr> <td>A</td> <td>standard</td> </tr> </tbody> </table>		specifcs		A	standard				
specifcs									
A	standard								
<table border="1"> <thead> <tr> <th colspan="2">options</th> </tr> </thead> <tbody> <tr> <td>A</td> <td>without</td> </tr> <tr> <td>C</td> <td>incremental encoder</td> </tr> </tbody> </table>		options		A	without	C	incremental encoder		
options									
A	without								
C	incremental encoder								
<table border="1"> <thead> <tr> <th colspan="2">motor connection</th> </tr> </thead> <tbody> <tr> <td>L</td> <td>stranded wire</td> </tr> </tbody> </table>		motor connection		L	stranded wire				
motor connection									
L	stranded wire								
<table border="1"> <thead> <tr> <th colspan="2">flange dimension</th> </tr> </thead> <tbody> <tr> <td>28</td> <td>28mm (NEMA11)</td> </tr> <tr> <td>42</td> <td>42mm (NEMA17)</td> </tr> <tr> <td>56</td> <td>56mm (NEMA23)</td> </tr> </tbody> </table>		flange dimension		28	28mm (NEMA11)	42	42mm (NEMA17)	56	56mm (NEMA23)
flange dimension									
28	28mm (NEMA11)								
42	42mm (NEMA17)								
56	56mm (NEMA23)								
<table border="1"> <thead> <tr> <th colspan="2">type</th> </tr> </thead> <tbody> <tr> <td>ST</td> <td>stepper motor</td> </tr> </tbody> </table>		type		ST	stepper motor				
type									
ST	stepper motor								
<table border="1"> <thead> <tr> <th colspan="2">product group</th> </tr> </thead> <tbody> <tr> <td>MOT</td> <td>motor</td> </tr> </tbody> </table>		product group		MOT	motor				
product group									
MOT	motor								

technical data						
flange dimension		28(NEMA11)	42(NEMA17)	56(NEMA23)		
motor						
max. voltage	[VDC]	60	60	60		
nominal voltage	[VDC]	24-48	24-48	24-48		
nominal current	[A]	1,0	1,8	4,2		
holding torque	[Nm]	0,12	0,5	2,0		
detent torque	[Nm]	0,004	0,022	0,068		
step angle	[°]	1,8 ±5%	1,8 ±5%	1,8 ±5%		
resistance / phase	[Ω]	2,30 ±15%	1,75 ±15%	0,50 ±10%		
inductance / phase	[mH]	1,80 ±20%	3,30 ±20%	2,20 ±20%		
moment of inertia / rotor	[kgcm ²]	0,018	0,082	0,48		
max. shaft load axial	[N]	50	100	500		
max. shaft load radial	[N]	-	-	-		

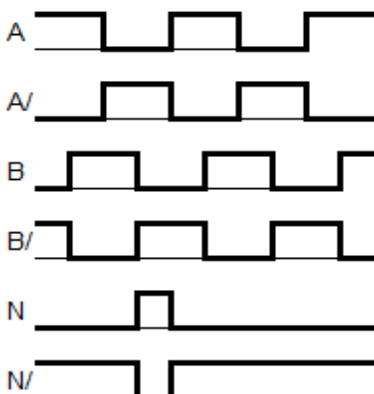
encoder		
operating voltage	[VDC]	5
impulse / turn	[1/min]	500
zero impulse / index		yes
line-driver		RS422 protocol
signal sequence (motor rotation clockwise)	CW	 <p>The diagram shows six digital signals over time. A and B are square waves with a phase shift. A' and B' are inverted versions of A and B. N is a single pulse, and N' is its inverted version.</p>

weight						
stranded wire	[kg]	0,25	0,34	1,00		
encoder	[kg]	0,27	0,36	1,02		

operating data		
ambient temperature	[°C]	-10 ...+50
max temperature rise	[°C]	80
insulation class		B
humidity (not condensing)	[%]	85
protection class engine case		IP40
CE		EMV guideline

pin assignment stepper motor
flange dimension 28,42,56 (NEMA11,17,23)

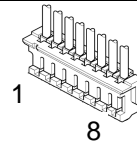
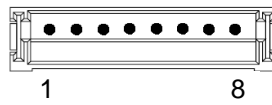
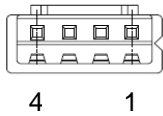

motor bipolar		
JST XHP-4		Litzen
pin	signal	color
1	A	white
2	A/	brown
3	B	blue
4	B/	black

encoder connector		encoder plug
JST / B8B-ZR-SM4-TF		JST / ZHR-8
pin	signal	color
1	GND	-
2	5V DC	-
3	A	-
4	A/	-
5	B/	-
6	B	-
7	I/	-
8	I	-

characteristic
flange dimension 28 (NEMA11)
MOT-ST-28-L-A-A

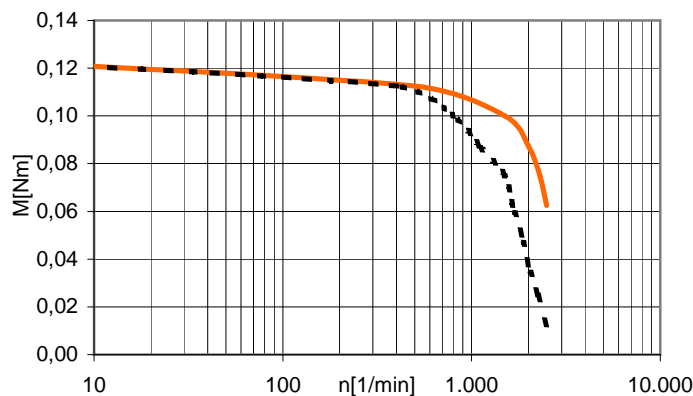

flange dimension 42 (NEMA17)
MOT-ST-42-L-A-A

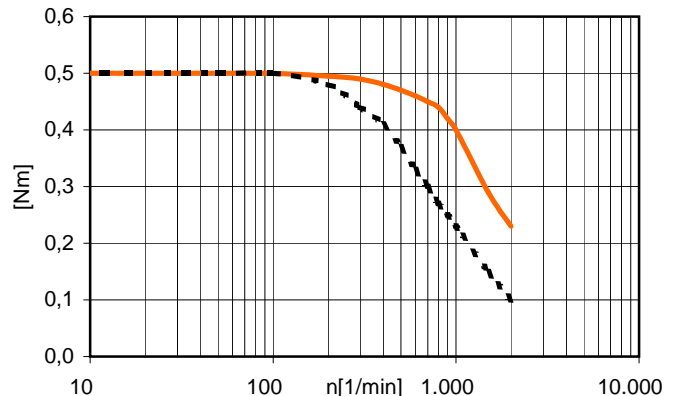

flange dimension 56 (NEMA23)
MOT-ST-56-L-A-A

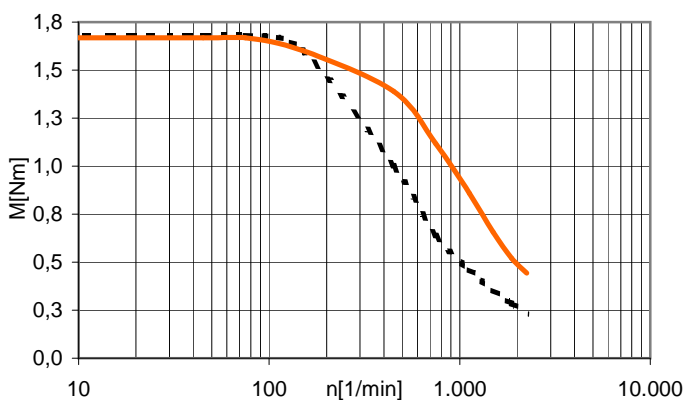

----- 24VDC ———— 48 VDC characteristic based on quarter step mode

dimension
MOT-ST-...-L-A-A

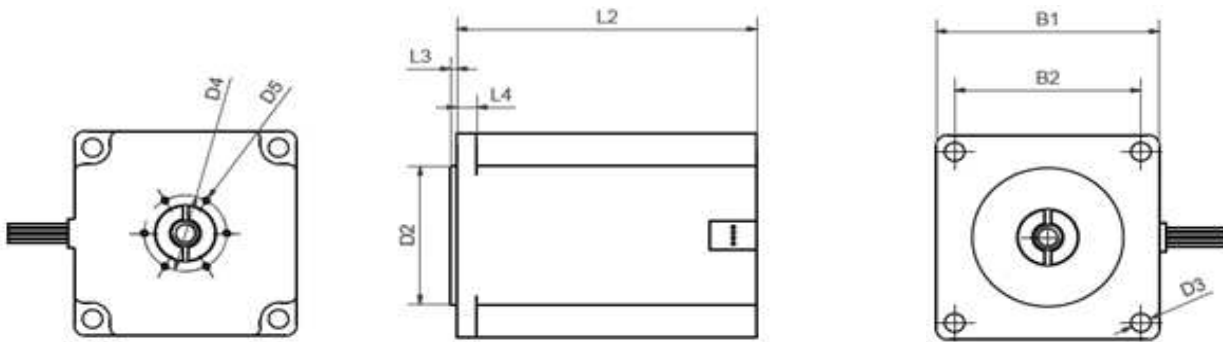

MOT-ST-...-L-C-A

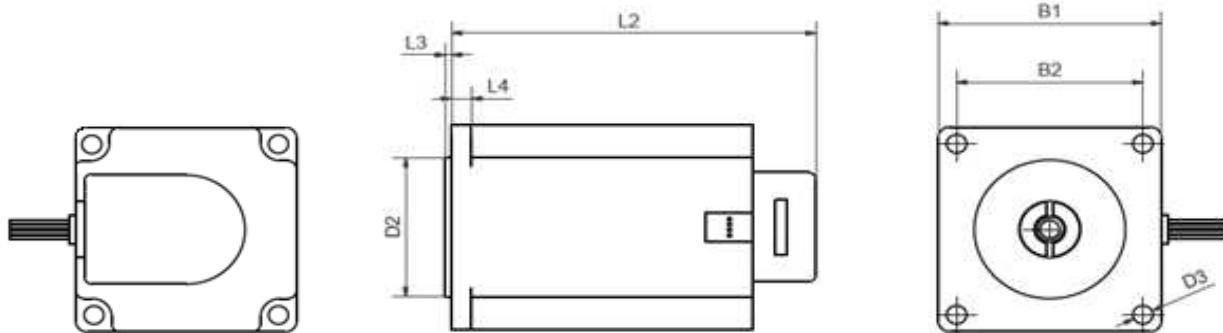

type

	B1 [mm]	B2 [mm] ±0,2	D2 Ø [mm] ±0,025	D3 Ø [mm]	D4 Ø [mm]	D5 Ø [mm]	L2 [mm] ±1	L3 [mm]	L4 [mm]
without Encoder									
MOT-ST-28-L-A-A	28,2	23,00	22,00	M2,5	19,05	2x M2-2	51	2,0	0
MOT-ST-42-L-A-A	42,3	31,00	22,00	M3	19,05	2x M2-2	49	2,0	0
MOT-ST-56-L-A-A	56,4	47,14	38,10	5	20,9	6x M2-2	76	1,6	5

	B1 [mm]	B2 [mm] ±0,2	D2 Ø [mm] ±0,025	D3 Ø [mm]	D4 Ø [mm]	D5 Ø [mm]	L2 [mm] ±1	L3 [mm]	L4 [mm]
with Encoder									
MOT-ST-28-L-C-A	28,2	23,00	22,00	M2,5	-	-	66,2	2,0	0
MOT-ST-42-L-C-A	42,3	31,00	22,00	M3	-	-	65	2,0	0
MOT-ST-56-L-C-A	56,4	47,14	38,10	5	-	-	92	1,6	5

component part						
spindle type						
part number	size	thread type	spindle Ø [mm]	pitch [mm]	max. length [mm]	material
PTGSG-MOT-M5X0,8-R-XXX-ES	28 (NEMA11)	M5	5	0,8	250	stainless steel
PTGSG-MOT-08X1,5-R-XXX-ES	42 (NEMA 17) 56 (NEMA 23)	TR	8	1,5	300	stainless steel
PTGSG-MOT-10X2-R-XXX-ES	42 (NEMA 17) 56 (NEMA 23)	TR	10	2	500	stainless steel
PTGSG-MOT-12X3-R-XXX-ES	42 (NEMA 17) 56 (NEMA 23)	TR	12	3	500	stainless steel
PTGSG-MOT-12X6P3-R-XXX-ES	42 (NEMA 17) 56 (NEMA 23)	TR	12	6P3	500	stainless steel
PTGSG-MOT-05X5-R-XXX-ES	28 (NEMA11)	SG	5	5	250	stainless steel
PTGSG-MOT-06.35X12.7-R-XXX-ES	28 (NEMA11)	SG	6,35	12,7	300	stainless steel
PTGSG-MOT-08X15-R-XXX-ES	42 (NEMA 17) 56 (NEMA 23)	SG	8	15	300	stainless steel
PTGSG-MOT-10X12-R-XXX-ES	42 (NEMA 17) 56 (NEMA 23)	SG	10	12	500	stainless steel
PTGSG-MOT-10X50-R-XXX-ES	42 (NEMA 17) 56 (NEMA 23)	SG	10	50	500	stainless steel
PTGSG-MOT-12X25-R-XXX-ES	42 (NEMA 17) 56 (NEMA 23)	SG	12	25	500	stainless steel

dryspin technology						
part number	size	thread type	spindle Ø [mm]	pitch [mm]	max. length [mm]	material
DST-LS-MOT-6.35X2.54-R-XXX-ES	28 (NEMA11)	DST	6,35	2,54	300	stainless steel
DST-LS-MOT-6.35X25.4-R-XXX-ES	28 (NEMA11)	DST	6,35	25,4	300	stainless steel
DST-LS-MOT-10X12-R-XXX-ES	42 (NEMA 17) 56 (NEMA 23)	DST	10	12	500	stainless steel
DST-LS-MOT-10X25-R-XXX-ES	42 (NEMA 17) 56 (NEMA 23)	DST	10	25	500	stainless steel
DST-LS-MOT-10X50-R-XXX-ES	42 (NEMA 17) 56 (NEMA 23)	DST	10	50	500	stainless steel

XXX: length of spindle

Spindle securing required via adhesive bond (Loctite 648)!

Curing time: after 6 hour approx. 50%, after 24 hour 100%

If required from the factory, please order with the following assembly number:

Installation in front: MONT004F000 (flange side)

Installation at the back: MONT004B000 (assembly not possible by motor with encoder)